

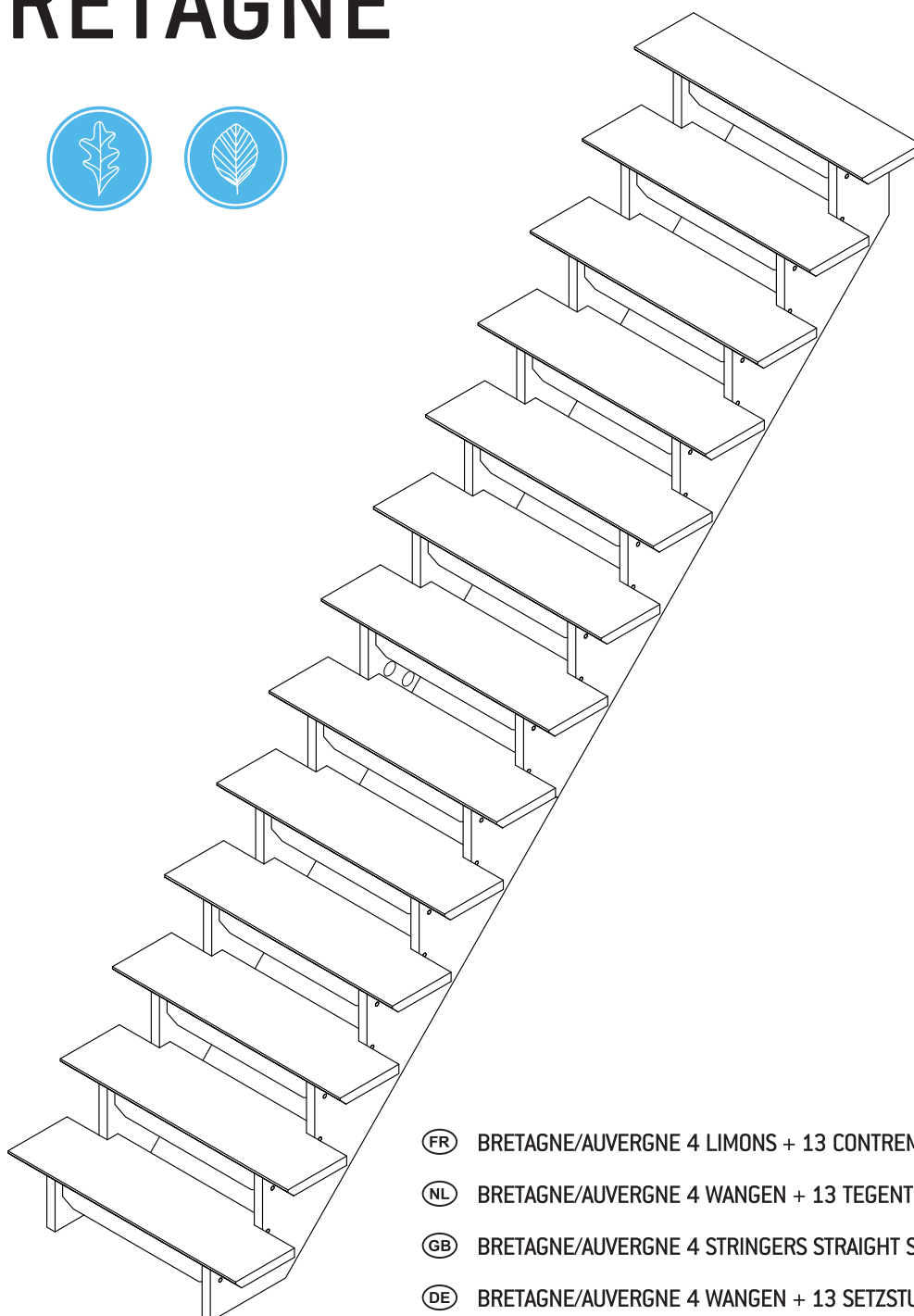

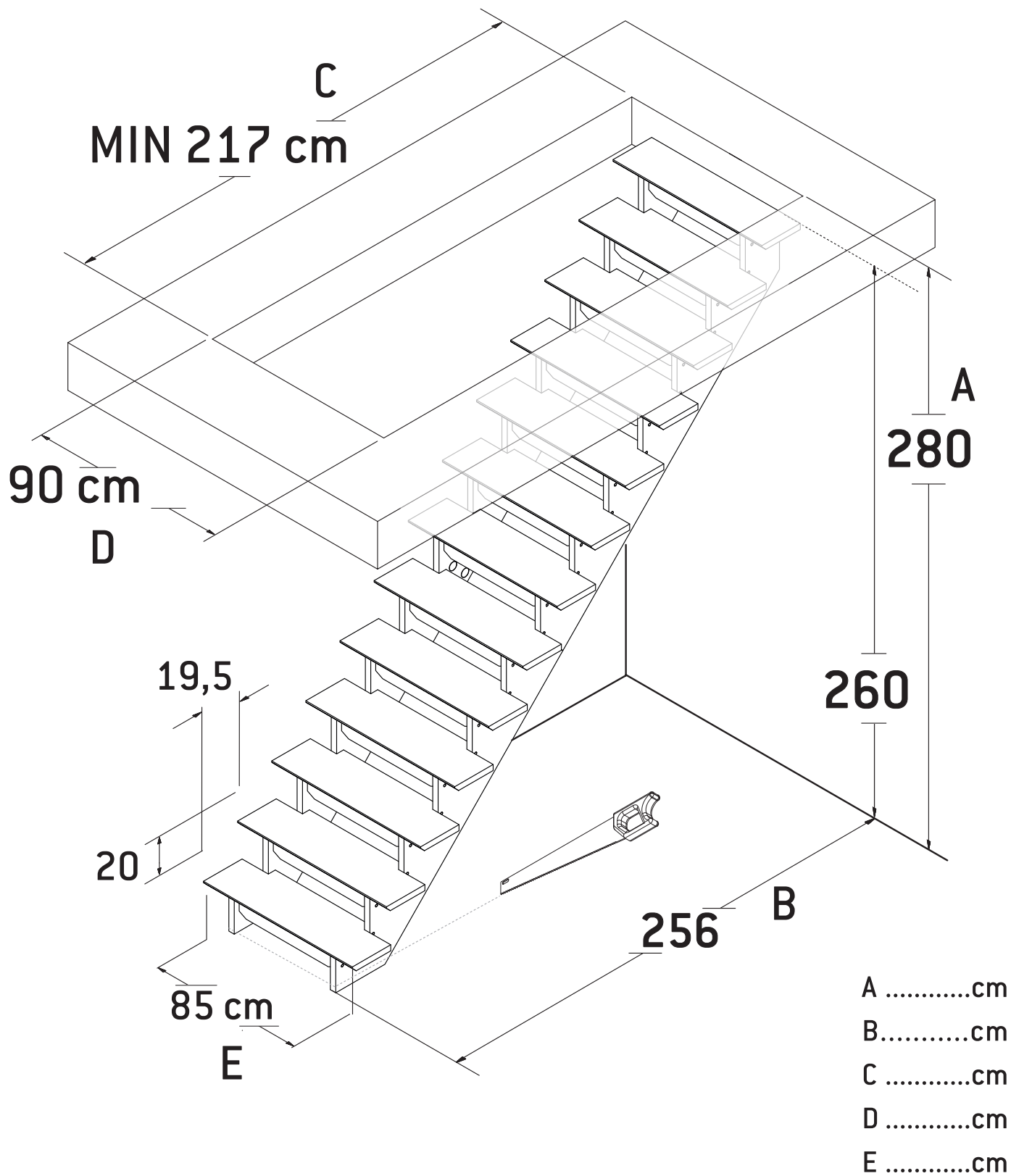





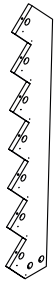

AUVERGNE BRETAGNE

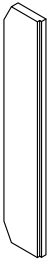
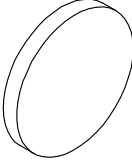
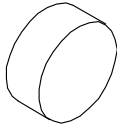

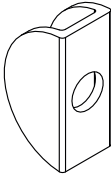
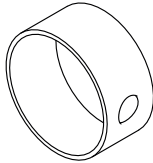
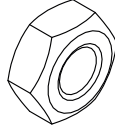
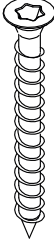
- Ⓡ BRETAGNE/AUVERGNE 4 LIMONS + 13 CONTREMARCHES
- Ⓡ BRETAGNE/AUVERGNE 4 WANGEN + 13 TEGENTREDEN
- Ⓡ BRETAGNE/AUVERGNE 4 STRINGERS STRAIGHT STAIR + 13 RISERS STAIRCASE
- Ⓡ BRETAGNE/AUVERGNE 4 WANGEN + 13 SETZSTUFEN
- Ⓡ BRETAGNE/AUVERGNE 4 ZANCAS ESCALERA RECTA + 13 CONTRAHUELLAS
- Ⓡ BRETAGNE/AUVERGNE 4 VANGURI SCARA DREAPTA +13 CONTRATREPTA SCARA



<p>01 30x320x1955 x1</p> 	<p>02 30x320x1955 x1</p> 	<p>03 30x320x1654 x1</p> 	<p>04 30x320x1654 x1</p> 
<p>05 18x95x550 13</p> 	<p>06 043x5 34+1</p> 	<p>07 012x5 52+1</p> 	<p>08 M8x160 4</p> 
<p>09 M8x68 26</p> 	<p>10 11x18x35 34</p> 	<p>11 037x040x19 34</p> 	<p>12 M8 34</p> 
<p>13 05x60 24+1</p> 	<p>14 04x45 26+1</p> 	 	

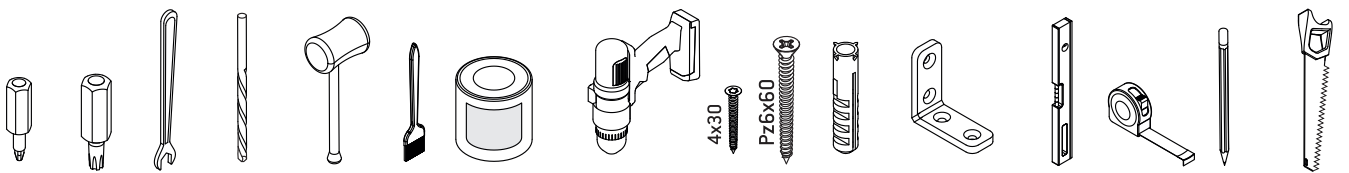

Ph2/3
Pz2/3 Tx10-30 13 010

1

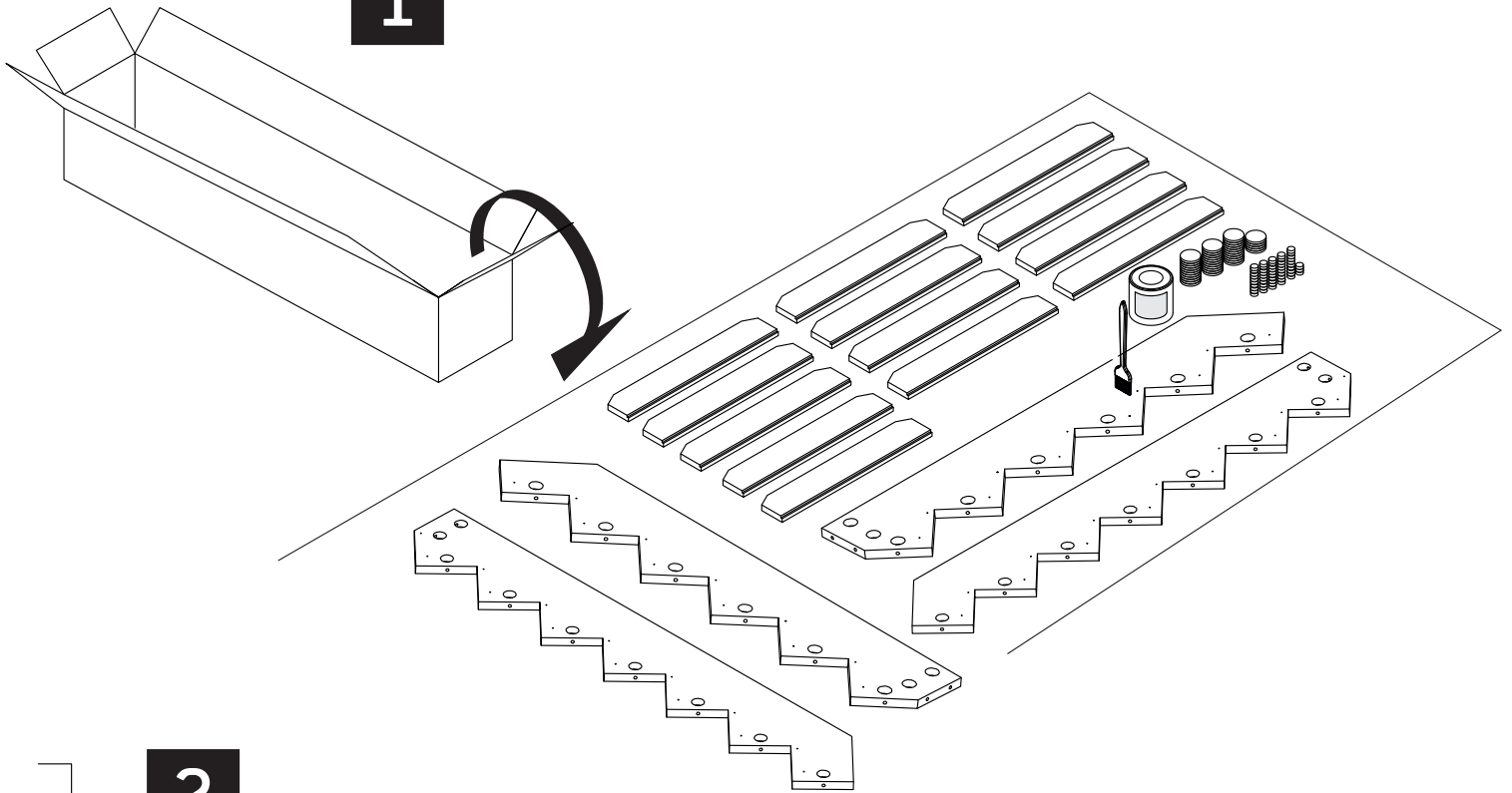

2

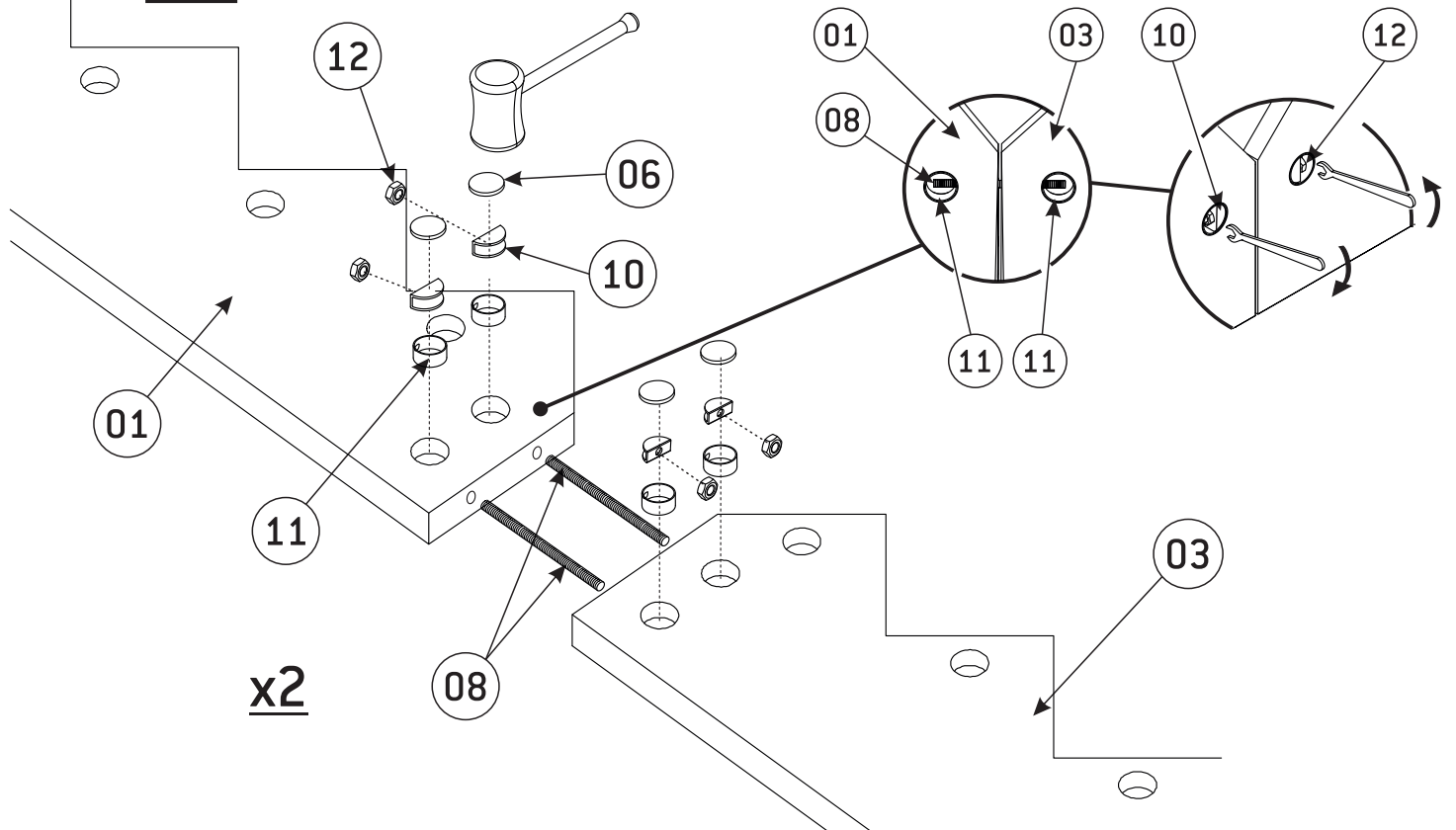

3

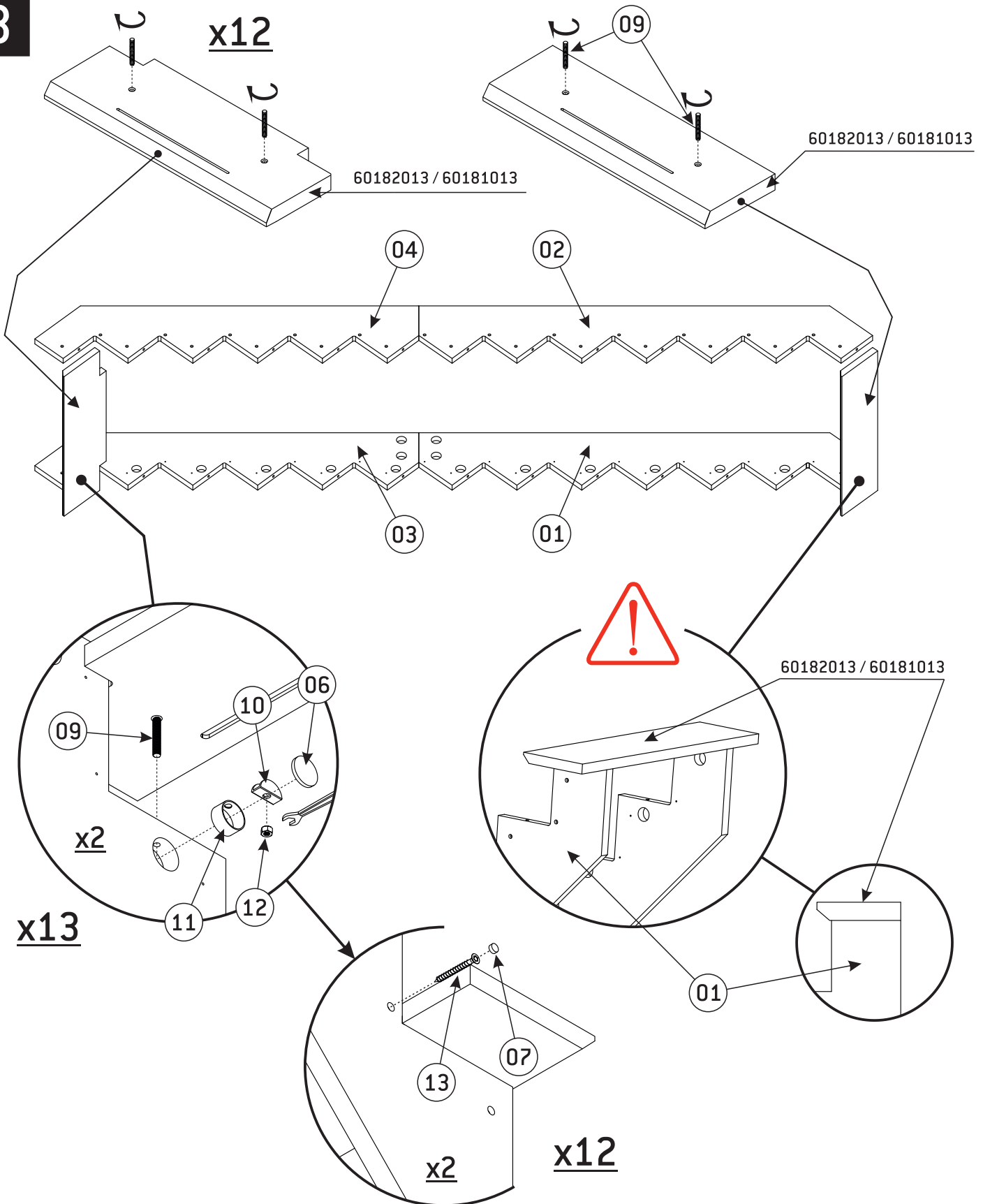

4

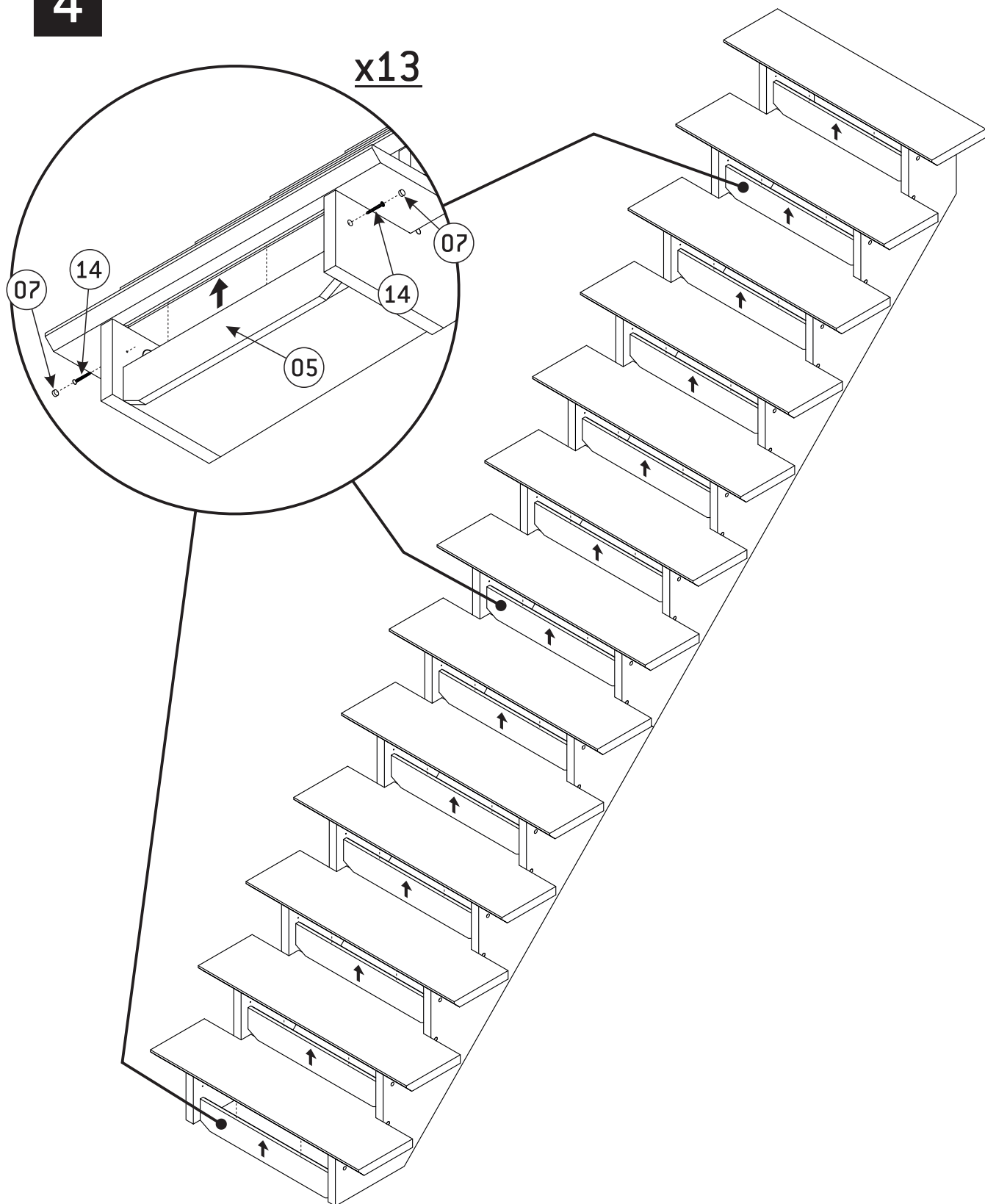

5

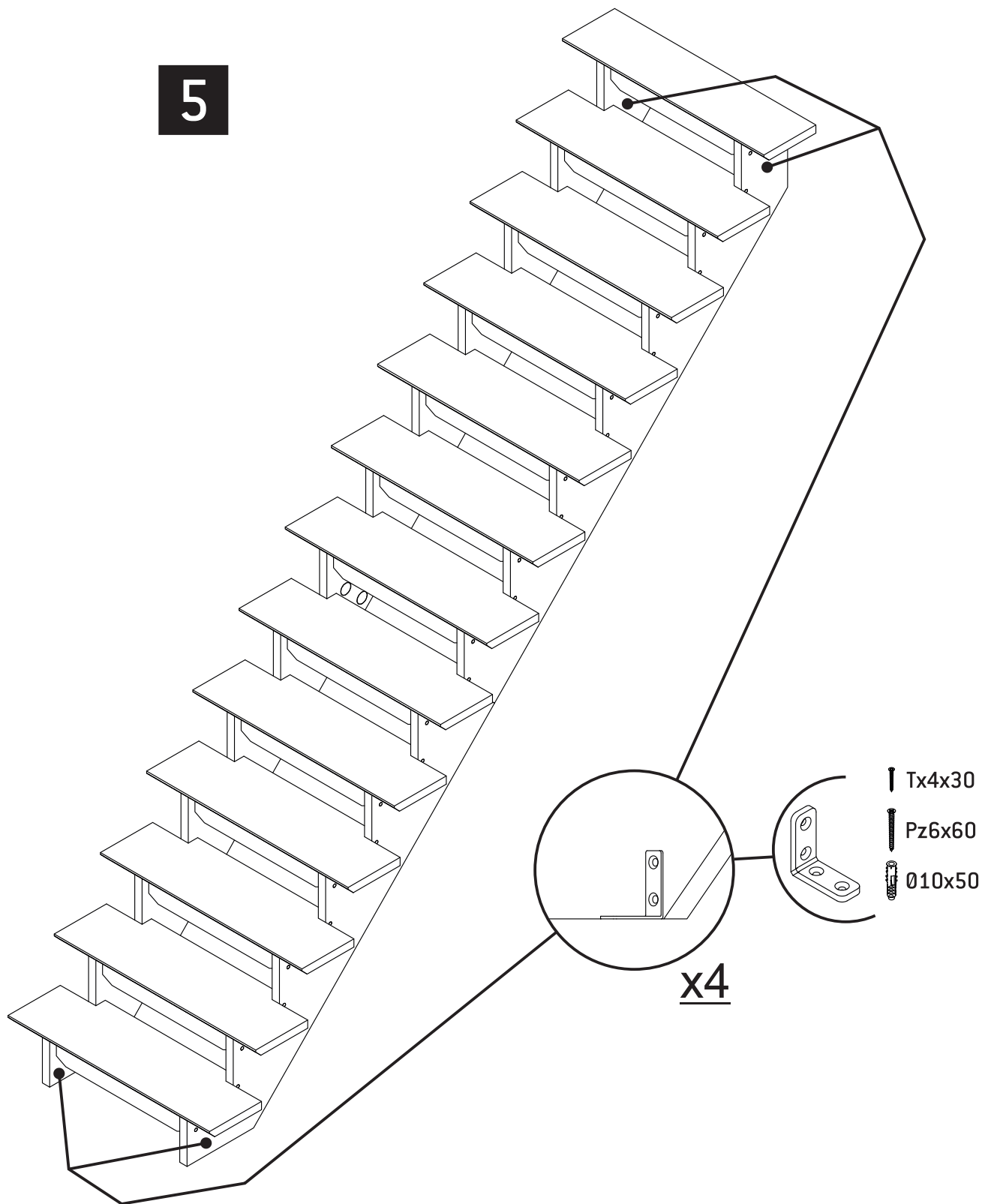

RUE GRIMARD, 39 B-6061 MONTIGNIES-SUR-SAMBRE (CHARLEROI) - BELGIUM
TEL: +32/71/25.39.60 FAX: +32/71/25.39.72 E-MAIL: info@sogem-sa.com